

# Biology 30

# Released Items

## 2014 Released Diploma Examination Items



For further information, contact

**Shannon Mitchell, Assessment Standards Team Leader**, at  
[Shannon.Mitchell@gov.ab.ca](mailto:Shannon.Mitchell@gov.ab.ca),

**Melissa McDonald, Examiner**, at  
[Melissa.McDonald@gov.ab.ca](mailto:Melissa.McDonald@gov.ab.ca) or

**Deanna Shostak, Director of Diploma Programs**, at  
780-415-6127 or [Deanna.Shostak@gov.ab.ca](mailto:Deanna.Shostak@gov.ab.ca) or

Assessment Sector: 780-427-0010.  
To call toll-free from outside Edmonton, dial 310-0000.

The [Alberta Education](http://education.alberta.ca) website is found at [education.alberta.ca](http://education.alberta.ca).

Copyright 2014, the Crown in Right of Alberta, as represented by the Minister of Education, Alberta Education, Assessment Sector, 44 Capital Boulevard, 10044 108 Street NW, Edmonton, Alberta T5J 5E6, and its licensors. All rights reserved.

**Special permission** is granted to **Alberta educators only** to reproduce, for educational purposes and on a non-profit basis, parts of this document that do **not** contain excerpted material.

# *Contents*

Introduction .....	1
Additional Documents.....	1
Biology 30 Diploma Examination April 2014–Blueprint Summary .....	2
Biology 30 Diploma Examination April 2014–Released Items .....	5

## ***Introduction***

The questions in this document are from the April 2014 administration of the Biology 30 Diploma Examination. This material, along with the Biology 30 Program of Studies, *Biology 30 Information Bulletin*, and school authority or school reports, can provide insight for teachers to assist them with instructional programming.

The blueprint summary on the following pages shows the keyed response, outcome classification according to the Program of Studies, classification of cognitive level, and the difficulty, indicated by the percentage of students who got the question correct, for each item. A complete explanation of the classification of cognitive level can be found in the *Biology 30 Information Bulletin*.

## ***Additional Documents***

The Assessment Sector supports the instruction of Biology 30 with the following documents:

- *Biology 30 Information Bulletin*, Biology 30 Archived Information Bulletin, and Biology 30 Assessment Exemplars

From [education.alberta.ca](http://education.alberta.ca), follow the pathway *Teachers > (Additional Programs and Services) Diploma Exams > Information Bulletins*.

These documents contain information about administrations of the diploma examinations for the upcoming school year, sample questions, and assessment samples for classroom use.

- Biology 30 Practice Tests  
Previous diploma examination questions and some practice questions have been released for Biology 30.  
<https://questaplus.alberta.ca>

## ***Biology 30 Diploma Examination, April 2014 Administration—Blueprint Summary***

**Key:** MC—Multiple Choice; NR—Numerical Response

K—Knowledge; C/A—Comprehension/Application; HMA—Higher Mental Activities

<b>Question</b>	<b>Key</b>	<b>Outcome</b>	<b>Cognitive Level</b>	<b>Difficulty (%)</b>
MC1	A	A1.1K	C/A	73.5
MC2	A	A1.2K	K	65.2
MC3	B	A1.1K	K	70.0
MC4	C	A1.2K	K	72.6
MC5	A	A1.2K, A1.2S	K	74.6
MC6	D	A1.5K	K	79.1
NR1	5136	A1.4K, A1.2S	K	55.6
MC7	A	A2.2K	C/A	72.8
MC8	D	A2.1K, A2.2STS	K	75.6
MC9	C	A2.2K, A2.2STS	C/A	56.8
MC10	C	A2.2K	K	73.5
MC11	A	A2.3K	K	66.4
MC12	B	A2.5K	K	53.4
MC13	C	B1.2K	C/A	57.0
MC14	B	B2.3K	K	64.9
MC15	B	B2.1K	K	56.1
NR2	2479 (any order)	B1.5K, B1.2S, B1.1STS	K	55.9
MC16	C	B2.2K, B2.1STS	K	51.2
NR3	213	B1.3K, B1.2S	K	53.7
MC17	A	B2.2K	C/A	64.2
MC18	D	B1.1K	C/A	84.0
MC19	D	B3.5K, B1.1STS	C/A	68.1
MC20	C	B3.2K, B1.1STS	C/A	64.4
MC21	C	B3.1K	C/A	61.0
MC22	D	B1.4K	C/A	66.2
MC23	D	B3.1K	K	83.7
MC24	B	C1.7K, C1.2S	C/A	72.1

**Key:** MC—Multiple Choice; NR—Numerical Response  
 K—Knowledge; C/A—Comprehension/Application; HMA—Higher Mental Activities

<b>Question</b>	<b>Key</b>	<b>Outcome</b>	<b>Cognitive Level</b>	<b>Difficulty (%)</b>
MC25	C	C1.1K, C1.2S	C/A	76.0
MC26	C	C1.2K	C/A	64.5
MC27	B	C1.5K	C/A	82.7
MC28	C	C1.3K	C/A	33.3
NR4	4132	C1.2K, C1.2S	K	78.3
NR5	2358 (any order)	C1.4K	K	56.7
MC29	B	C1.7K, C1.3S	HMA	55.9
MC30	B	C1.7K, C1.2S	C/A	43.3
MC31	A	C2.2K, C2.3S	C/A	48.7
NR6	3241	C2.5K, C2.3S	C/A	49.2
MC32	A	C2.2K, C2.3S	C/A	53.3
MC33	A	C2.2K, C2.3S	C/A	78.2
MC34	D	C2.4K, C2.3S	HMA	50.4
MC35	D	C2.5K, C2.3S	C/A	78.1
NR7	3.1 or 29.1	C2.3K, C2.3S	C/A	80.4
MC36	B	C3.3K	C/A	55.8
MC37	B	C3.3K	K	61.4
NR8	1221	C3.3K, C3.2S	C/A	59.5
MC38	A	C3.3K, C3.2S	C/A	59.5
MC39	C	C3.6K, C3.2S	C/A	65.1
NR9	6513	C3.6K, C3.2S	C/A	75.7
MC40	C	C3.4K, C3.2S	K	62.2
MC41	D	C3.2K, C3.2S	C/A	74.0
NR10	0.37	D1.3K, D1.3S	C/A	53.1
MC42	A	D1.1K, D1.2STS	C/A	68.3
MC43	B	D1.2K	C/A	75.6
MC44	B	D2.3K	C/A	47.3
MC45	C	D2.1K, D2.3S	C/A	68.0

**Key:** MC—Multiple Choice; NR—Numerical Response  
 K—Knowledge; C/A—Comprehension/Application; HMA—Higher Mental Activities

<b>Question</b>	<b>Key</b>	<b>Outcome</b>	<b>Cognitive Level</b>	<b>Difficulty (%)</b>
MC46	D	D2.1K, D2.3S, D2.1STS	C/A	58.5
MC47	D	D3.1K, D1.1STS	C/A	67.2
NR11	116 or 117	D3.2K, D3.3S	C/A	89.7
NR12	0.02	D3.2K, D3.3S	C/A	63.4
MC48	B	D3.3K	C/A	68.8

*Use the following information to answer the first two questions.*

Olfaction is the sense that enables organisms to distinguish and interpret odours. An action potential is initiated when a chemical interacts with an odour-receptor protein in the cell membrane of a sensory neuron in the nasal cavity.

1. The interaction of a chemical with an odour-receptor protein **first** causes the movement of
  - A. sodium ions into a sensory neuron
  - B. sodium ions out of a sensory neuron
  - C. potassium ions into a sensory neuron
  - D. potassium ions out of a sensory neuron
  
2. The area of the brain where odours are interpreted is the
  - A. cerebrum
  - B. cerebellum
  - C. hypothalamus
  - D. medulla oblongata



*Use the following information to answer the next two questions.*

Neurofibromatosis is a genetic disorder characterized by the growth of tumours called neurofibromas around some neurons. Neurofibromas result from the uncontrolled growth of cells that produce the myelin sheath.

3. The structures that are affected by neurofibromas are the
- A. axons of neurons in grey matter
  - B. axons of neurons in white matter
  - C. dendrites of neurons in grey matter
  - D. dendrites of neurons in white matter

*Use the following additional information to answer the next question.*

Two types of neurofibromatosis have been identified. In type 1 neurofibromatosis, tumours form around nerves in the peripheral nervous system.

4. The neurons that are affected in type 1 neurofibromatosis are
- A. autonomic neurons and interneurons
  - B. neurons in the brain and interneurons
  - C. autonomic neurons and somatic neurons
  - D. neurons in the brain and somatic neurons

Use the following information to answer the next two questions.

Ataxia, which has many different forms and causes, is a condition characterized by a decreased ability to coordinate muscle movements. One form of ataxia affects the part of the nervous system that controls balance and coordination.

### The Human Brain

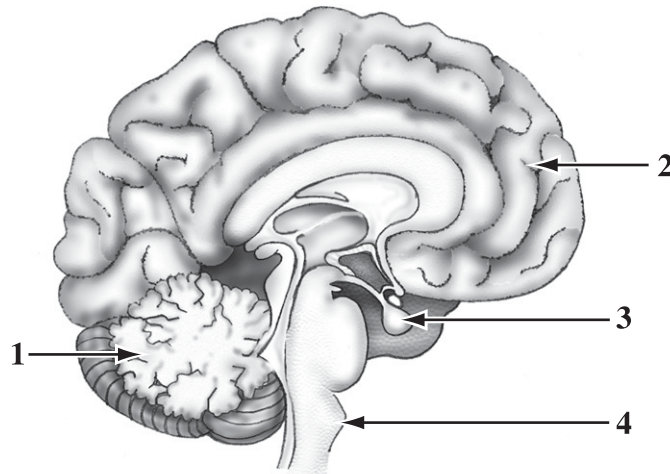

5. In the diagram above, the part of the brain that is affected in the form of ataxia described above is numbered
- A. 1
  - B. 2
  - C. 3
  - D. 4

Use the following additional information to answer the next question.

Another form of ataxia is caused by the abnormal functioning of structures in the ear that play a role in balance.

6. The structures of the ear that could be affected in a person with ataxia are the
- A. ossicles
  - B. auditory canals
  - C. cochlear hair cells
  - D. semicircular canals

Use the following diagram to answer the next question.

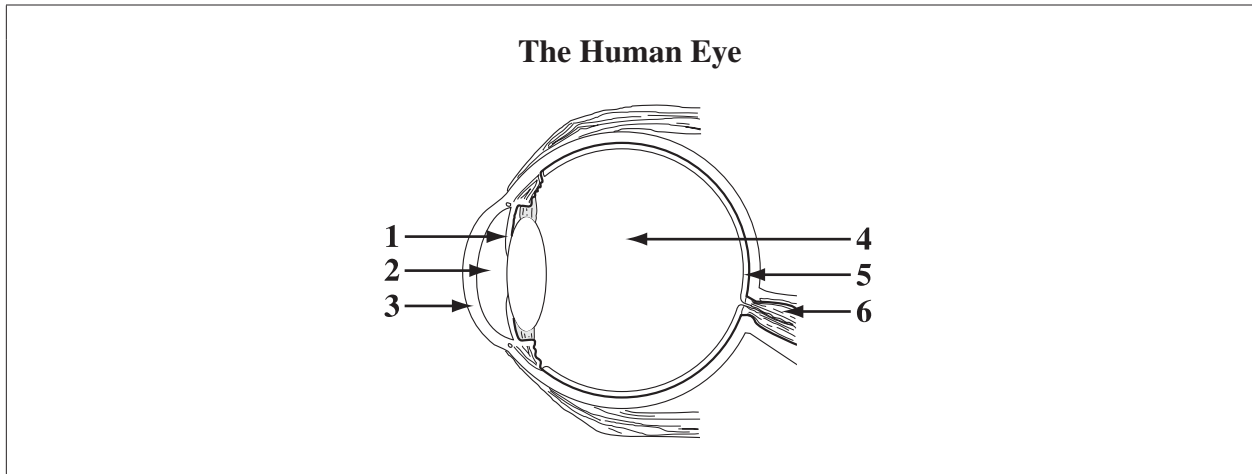

### Numerical Response

1. Match four of the numbers in the diagram above with the names of the structures given below.

**Number:** \_\_\_\_\_  
**Name:** Retina      Iris      Cornea      Optic nerve

(Record all **four digits** of your answer in the numerical-response section on the answer sheet.)

\_\_\_\_\_

Use the following information to answer the next question.

Pituitary dwarfism is an inherited condition that occurs in some dog breeds. A dog with pituitary dwarfism frequently has decreased secretion of several pituitary hormones, which results in abnormal functioning of other endocrine glands.

—based on *Canine Inherited Disorders Database*, 2010

Canine Inherited Disorders Database. 2010. Inherited endocrine disorders: Pituitary dwarfism (Hypopituitarism). *Canine Inherited Disorders Database*. <http://www.upei.ca/cidd/intro.htm>.

7. Two expected symptoms of pituitary dwarfism in dogs are
- A. hypothyroidism and decreased metabolic rate
  - B. hyperthyroidism and increased metabolic rate
  - C. hypoparathyroidism and decreased metabolic rate
  - D. hyperparathyroidism and increased metabolic rate

Use the following information to answer the next two questions.

A drug known as exenatide is used in the treatment of type 2 diabetes. Exenatide stimulates the secretion of insulin and reduces the activity of glucagon.

### Some Glands in a Human

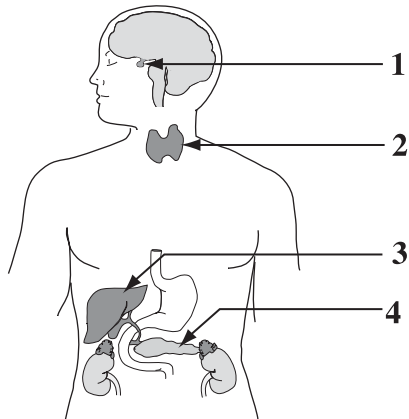

8. In the diagram above, the gland that is targeted by exenatide is labelled
- A. 1
  - B. 2
  - C. 3
  - D. 4
9. Exenatide causes blood glucose levels to
- A. increase by causing an increase in the permeability of cells to glucose
  - B. increase by causing a decrease in the permeability of cells to glucose
  - C. decrease by causing an increase in the permeability of cells to glucose
  - D. decrease by causing a decrease in the permeability of cells to glucose

Use the following information to answer the next two questions.

A man had high blood pressure and experienced muscle weakness and paralysis. These symptoms were caused by long-term exposure to licorice root, which the man consumed in his daily tea. Licorice root contains a substance that mimics the effects of high amounts of aldosterone and cortisol.

—based on Lin et al., 2003

Lin, Shih-Hua, Sung-Sen Yang, Tom Chau, and Mitchell L. Halperin. 2003. An unusual cause of hypokalemic paralysis: Chronic licorice ingestion. *American Journal of the Medical Sciences* 325 (3): 153–156.

10. The man's symptoms were caused by a substance that mimics the effects of hormones secreted by the
- A. thyroid gland
  - B. hypothalamus
  - C. adrenal glands
  - D. pituitary gland
11. A higher-than-normal amount of aldosterone causes
- A. increased sodium reabsorption by the kidneys
  - B. decreased sodium reabsorption by the kidneys
  - C. decreased water reabsorption by the kidneys
  - D. increased glucose reabsorption by the kidneys

Use the following diagram to answer the next question.

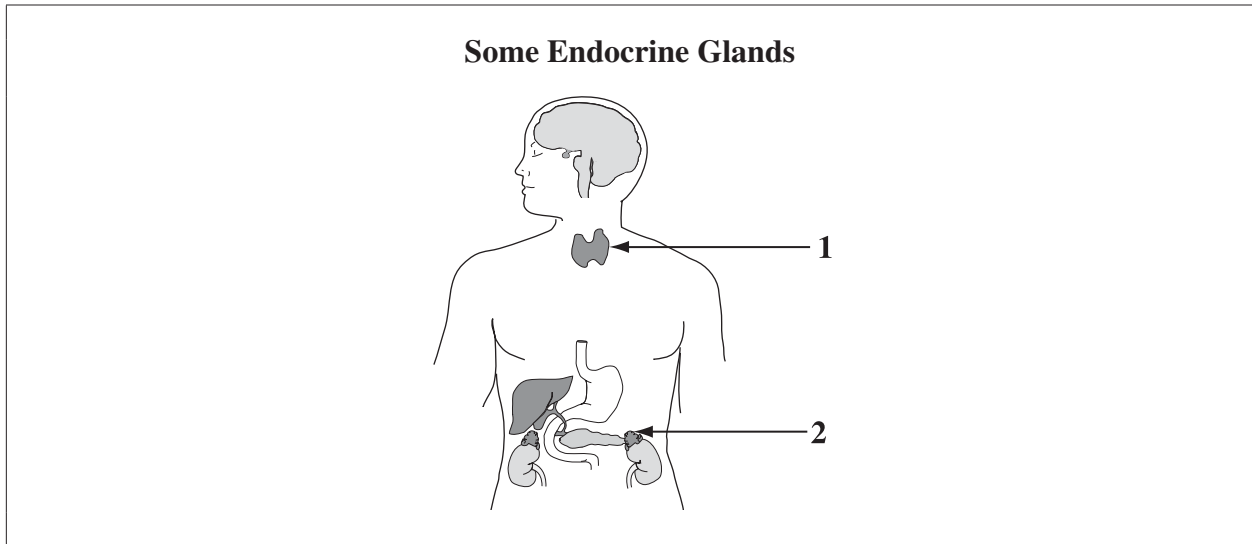

12. In the diagram above, the gland that releases a hormone in response to short-term stress is numbered
- A. 1, and it releases the hormone after being stimulated by the nervous system
  - B. 2, and it releases the hormone after being stimulated by the nervous system
  - C. 1, and it releases the hormone after being stimulated by the endocrine system
  - D. 2, and it releases the hormone after being stimulated by the endocrine system

Use the following information to answer the next question.

In 1979, a young man had samples of his sperm frozen prior to undergoing treatment for testicular cancer. The cancer treatment was successful, but it made the man infertile. The sperm that had been frozen were used for in vitro fertilization, which resulted in the birth of a healthy baby boy in 2002.

—based on Horne et al., 2004

Horne, G., A. D. Atkinson, E. H. E. Pease, J. P. Logue, D. R. Brison, and B. A. Lieberman. 2004. Live birth with sperm cryopreserved for 21 years prior to cancer treatment: Case report. *Human Reproduction* 19 (6): 1448–1449.

13. Which of the following rows identifies the structures that were damaged by the cancer treatment and the process that normally occurs in the structures?

Row	Structures Damaged	Process
A.	Interstitial cells	Gamete formation
B.	Interstitial cells	Gamete maturation
C.	Seminiferous tubules	Gamete formation
D.	Seminiferous tubules	Gamete maturation

Use the following information to answer the next question.

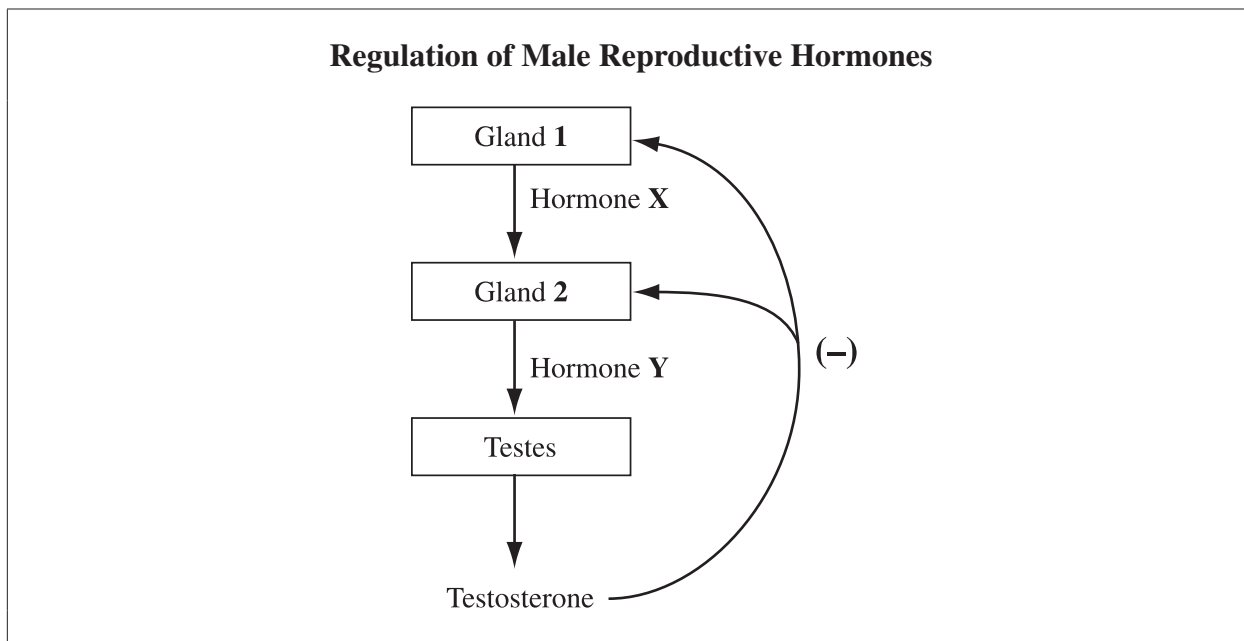

14. Which of the following rows identifies Gland 1, Gland 2, Hormone X, and Hormone Y, as shown in the diagram above?

Row	Gland 1	Gland 2	Hormone X	Hormone Y
A.	Pituitary gland	Hypothalamus	LH	GnRH
B.	Hypothalamus	Pituitary gland	GnRH	LH
C.	Hypothalamus	Pituitary gland	GnRH	FSH
D.	Pituitary gland	Hypothalamus	FSH	GnRH

15. The development of gametes at puberty is stimulated by the production of
- A. LH in both females and males
  - B. FSH in both females and males
  - C. FSH in females and LH in males
  - D. estrogen in females and testosterone in males

Use the following information to answer the next question.

Gonorrhea and chlamydia are two sexually transmitted infections (STIs) that are caused by bacteria. The bacteria cause inflammation of the prostate gland and the epididymis, and they infect the cervix and vagina.

### Male and Female Reproductive Systems

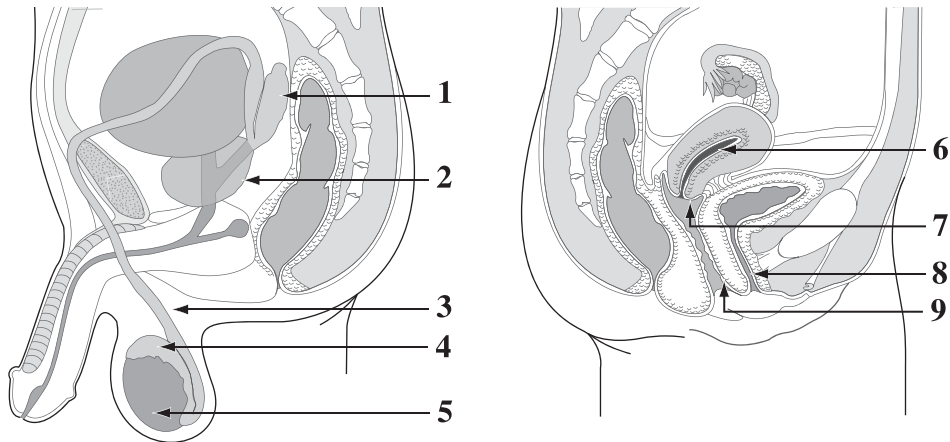

### Numerical Response

2. The structures of the male and female reproductive systems numbered above that are affected by gonorrhea and chlamydia are \_\_\_\_\_, \_\_\_\_\_, \_\_\_\_\_, and \_\_\_\_\_.

(Record all **four digits** of your answer **in any order** in the numerical-response section on the answer sheet.)

\_\_\_\_\_

Use the following information to answer the next question.

During menopause, some women take hormone replacement therapy (HRT). A woman may take estrogen alone, progesterone alone, or a combination of estrogen and progesterone administered together.

16. When a woman's HRT includes a combination of estrogen and progesterone administered together, the hormones replaced are those normally secreted by the
- A. uterus
  - B. follicle
  - C. corpus luteum
  - D. pituitary gland



Use the following information to answer the next question.

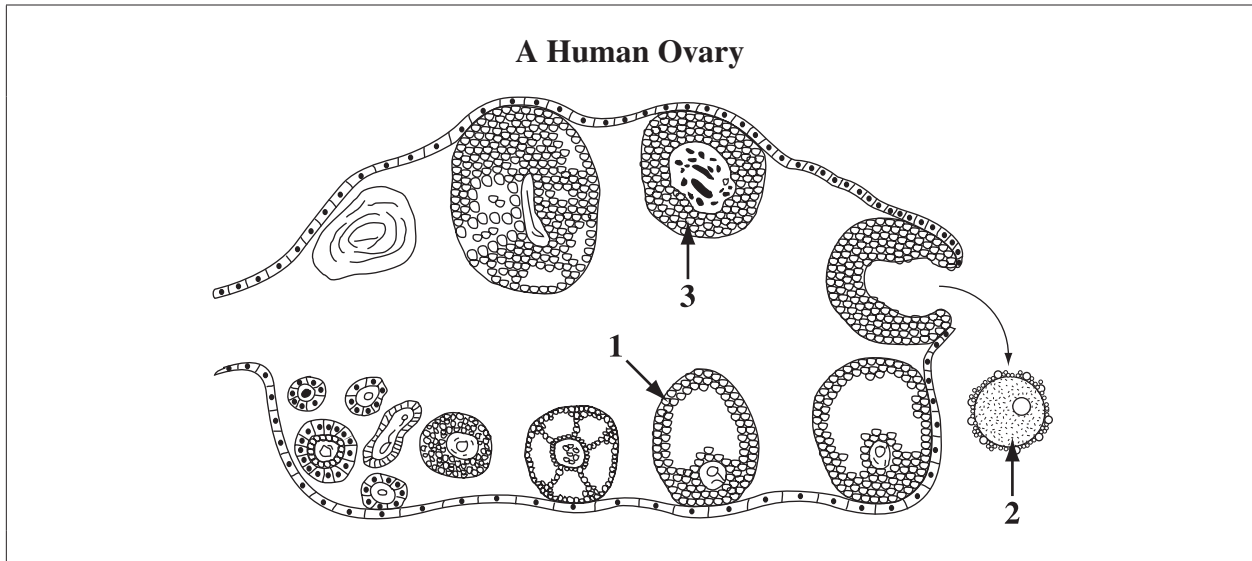

### Numerical Response

3. Match each structure in the human ovary numbered above with its name given below.

Structure: \_\_\_\_\_  
Name: **Ovum**                      **Follicle**                      **Corpus luteum**

(Record all **three digits** of your answer in the numerical-response section on the answer sheet.)

\_\_\_\_\_

Use the following information to answer the next two questions.

A tumour in the pituitary gland can alter the secretion of hormones from the gland. The most common type of pituitary tumour is an endocrine-inactive tumour, which destroys some of the hormone-producing cells in the pituitary gland.

17. In a woman, a symptom of an endocrine-inactive tumour in the pituitary gland could be
- A. a stopping of the menstrual cycle
  - B. a decrease in secretion of GnRH
  - C. an increase in follicular development
  - D. an increase in secretion of progesterone

18. A structure whose function is **not** affected by an endocrine-inactive tumour is the
- A. follicle
  - B. endometrium
  - C. corpus luteum
  - D. Fallopian tube
- 

*Use the following information to answer the next two questions.*

Preimplantation genetic diagnosis is a screening procedure that is performed on an embryo after in vitro fertilization and before implantation. During the procedure, one cell is removed from a mass of eight cells and is screened for genetic abnormalities. If no abnormalities are present, the remaining mass of seven cells is placed into a woman's uterus.

19. A cell that is removed from a mass of eight cells is useful for genetic screening because it
- A. is more specialized than a zygote
  - B. has undergone many cell divisions
  - C. contains one copy of each human chromosome
  - D. contains a complete set of human chromosomes
20. A cell can be removed from a mass of eight cells for genetic screening without affecting the development of the embryo and fetus because the remaining seven cells have
- A. differentiated
  - B. been fertilized
  - C. not differentiated
  - D. not been fertilized
- 
21. In a pregnant woman, one effect of a lower-than-normal amount of hCG could be the inability to
- A. ovulate
  - B. develop mature follicles
  - C. maintain the endometrium
  - D. produce other gonadotropic hormones

Use the following information to answer the next question.

The presence of fetal testosterone during development results in the development of male reproductive organs in the fetus. In the absence of testosterone, the fetus will develop female reproductive organs.

22. Which of the following statements describes a genotypically male fetus that developed in the absence of testosterone?
- A. The fetus has two X chromosomes and is phenotypically male.
  - B. The fetus has two X chromosomes and is phenotypically female.
  - C. The fetus has X and Y chromosomes and is phenotypically male.
  - D. The fetus has X and Y chromosomes and is phenotypically female.

23. Which of the following rows identifies the hormone that stimulates uterine contractions during labour and the gland from which this hormone is secreted?

Row	Hormone	Gland
A.	Estrogen	Ovary
B.	Estrogen	Pituitary gland
C.	Oxytocin	Ovary
D.	Oxytocin	Pituitary gland

Use the following information to answer the next two questions.

A yeast called *Saccharomyces cerevisiae* has the ability to reproduce both asexually and sexually. When conditions are favourable, the yeast cells reproduce through a process known as budding, which produces cells that are identical to the mother cell. When conditions become unfavourable, yeast cells produce spores that function much like gametes.

**Life Cycle of *Saccharomyces cerevisiae***

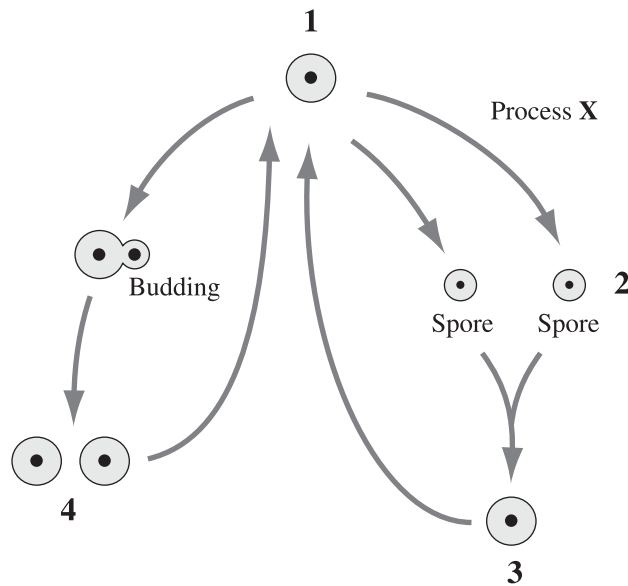

24. In the life cycle shown above, Process X is

- A. mitosis
- B. meiosis
- C. cloning
- D. fertilization

25. Which of the following rows describes the chromosome content of the cells numbered 2 and the chromosome content of the cells numbered 4 in the life cycle shown above?

Row	Cells 2	Cells 4
A.	Diploid	Diploid
B.	Haploid	Haploid
C.	Haploid	Diploid
D.	Diploid	Haploid

Use the following information to answer the next two questions.

Mitosis must be carefully regulated to ensure the normal distribution of chromosomes to the daughter cells. A ring-shaped protein molecule known as cohesin attaches to the centromere of a chromosome and holds sister chromatids together to prevent their premature separation. Enzymes detach cohesin molecules from the centromere immediately before the sister chromatids segregate.

—based on *Nature*, 2006

Megee, Paul. 2006. Chromosome guardians on duty. *Nature* 441, no. 7089 (May 4): 35–36.

26. The phase of mitosis during which enzymes detach cohesin molecules from the centromere is
- A. late prophase
  - B. late anaphase
  - C. early anaphase
  - D. early metaphase
27. The failure of enzymes to detach cohesin molecules from the centromere could result in
- A. recombination
  - B. nondisjunction
  - C. reduction division
  - D. unequal cytokinesis
- 
28. In organisms that reproduce sexually, the **primary** purpose of meiosis is the
- A. replication of genetic material
  - B. independent assortment of genes
  - C. reduction of chromosome number
  - D. production of identical daughter cells

Use the following information to answer the next question.

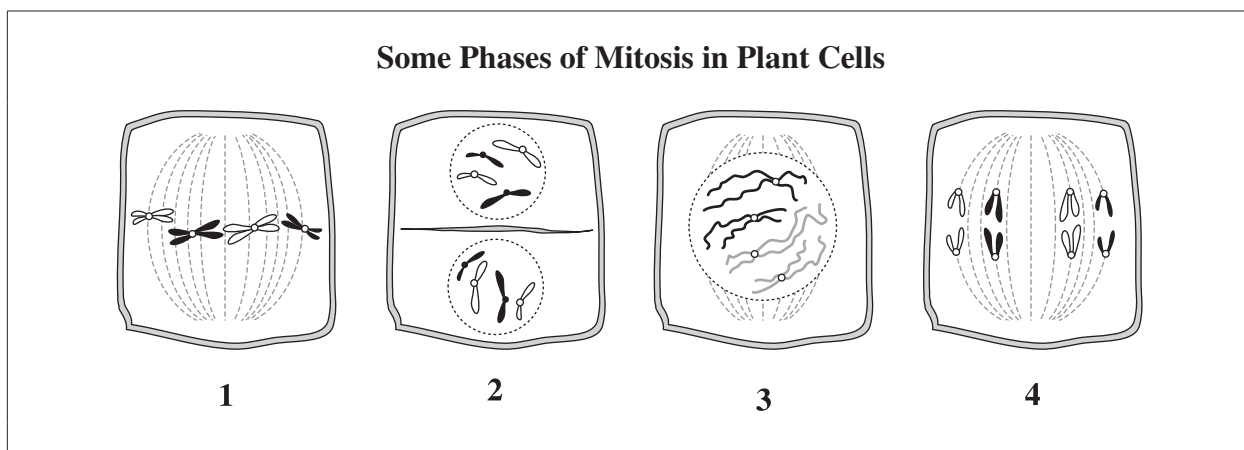

### Numerical Response

4. Match each phase of mitosis numbered above with its name given below.

Phase: \_\_\_\_\_  
Name: Anaphase      Metaphase      Prophase      Telophase

(Record all **four digits** of your answer in the numerical-response section on the answer sheet.)

\_\_\_\_\_

Use the following information to answer the next question.

**Some Statements About Cell Division**

- 1 Diploid cells are produced.
- 2 Haploid cells are produced.
- 3 Four gametes are produced.
- 4 Two somatic cells are produced.
- 5 Cell division occurs only in the gonads.
- 6 Cell division occurs in most body tissues.
- 7 The products are genetically identical to the parent cells.
- 8 The products are genetically different from the parent cells.

### Numerical Response

5. The statements about cell division numbered above that describe meiosis are \_\_\_\_\_, \_\_\_\_\_, \_\_\_\_\_, and \_\_\_\_\_.

(Record all **four digits** of your answer **in any order** in the numerical-response section on the answer sheet.)

Use the following information to answer the next two questions.

Adult butterflies are diploid. The sex chromosomes in adult female butterflies are W and Z chromosomes, whereas the sex chromosomes in adult male butterflies are two Z chromosomes.

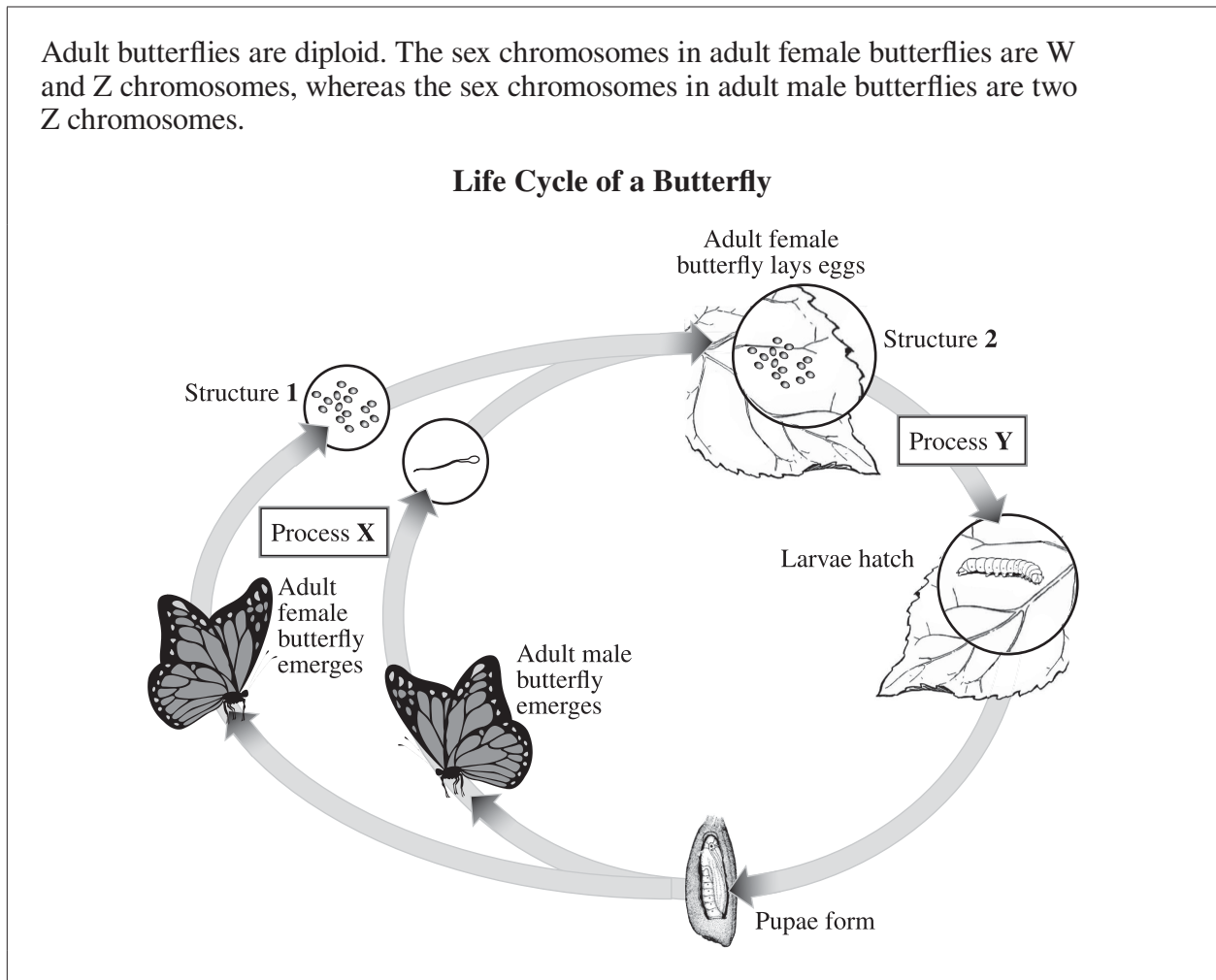

29. A karyotype of Structure 1 in the diagram above would have
- two copies of each autosome and two Z chromosomes
  - one copy of each autosome and either a W or a Z chromosome
  - one copy of each autosome, a W chromosome, and a Z chromosome
  - two copies of each autosome, a W chromosome, and a Z chromosome
30. Which of the following rows identifies Process X and Process Y as shown in the diagram above?

Row	Process X	Process Y
A.	Meiosis	Fertilization
B.	Meiosis	Mitosis
C.	Fertilization	Mitosis
D.	Fertilization	Differentiation

Use the following information to answer the next question.

The Kermode bear, also called “spirit bear” by the Tsimshian people, is a subspecies of the black bear and is found on Princess Royal Island, British Columbia. Most Kermode bears have a black coat, but a small number have a white coat, which is caused by the presence of two autosomal recessive alleles.

31. Two heterozygous Kermode bears mate and produce a cub. What is the probability that their cub is female and has a white coat?
- A. 0.13
  - B. 0.25
  - C. 0.50
  - D. 0.75

Use the following information to answer the next question.

In rare cases, single gene mutations can cause obesity in humans. The mode of inheritance of these mutated genes can be autosomal recessive, autosomal dominant, X-linked recessive, or X-linked dominant.

—based on Centers for Disease Control and Prevention, 2005

Office of Genomics and Disease Prevention. 2005. Obesity: Single gene disorders that have obesity as primary feature. *Public Health Perspectives*. Centers for Disease Control and Prevention. <http://www.cdc.gov/genomics/info/perspectives/files/obesdisord.htm> (accessed March 11, 2005).

### Descriptions of Some Forms of Hereditary Obesity

- 1 All daughters of a man who has this form of hereditary obesity are affected and none of his sons are affected.
- 2 Two unaffected parents cannot produce an affected child with this form of hereditary obesity.
- 3 To be affected with this form of hereditary obesity, a person must be homozygous for the mutated gene.
- 4 In this form of hereditary obesity, a female requires two mutated alleles to be affected, whereas a male requires only one.

### Numerical Response

6. Match each description of hereditary obesity given above with its mode of inheritance given below. (Use each number only once.)

<b>Description:</b>	_____	_____	_____	_____
<b>Mode of Inheritance:</b>	<b>Autosomal recessive</b>	<b>Autosomal dominant</b>	<b>X-linked recessive</b>	<b>X-linked dominant</b>

(Record all **four digits** of your answer in the numerical-response section on the answer sheet.)



Use the following information to answer the next two questions.

The eumelanin gene determines coat colour in dogs. The dominant allele ( $E$ ) produces a black coat, and the recessive allele ( $e$ ) produces a red coat. The merle gene controls the expression of colour. The merle alleles are incompletely dominant, as shown below.

Genotype	Phenotype
$mm$	Full colour (either black or dark red)
$Mm$	Dilute colour (either grey or light red)
$MM$	White

The eumelanin and merle genes are located on two different autosomes.

32. A grey dog that is homozygous dominant for eumelanin mates with a dark red dog. The phenotypes that are possible in their offspring are
- A. grey and black
  - B. black and white
  - C. grey and dark red
  - D. dark red and black

Use the following additional information to answer the next question.

A dog breeder wants to determine the genotype of her white dog. To do so, she mates her dog with another dog in a test cross. Some of the puppies produced have grey coats, and the remainder of the puppies have light red coats.

33. Which of the following rows identifies the genotype of the breeder's white dog and the phenotype of the other dog in the test cross?

Row	Genotype of the White Dog	Phenotype of the Other Dog
A.	$EeMM$	Dark red
B.	$Eemm$	Dark red
C.	$eeMM$	White
D.	$eemm$	White

Use the following information to answer the next question.

A form of congenital deafness is inherited as a result of the interaction between two genes, *D* and *E*, which assort independently.

Genotype	Phenotype
<i>D</i> _ <i>E</i> _	Normal hearing
<i>dd</i> _ _	Deaf
_ _ <i>ee</i>	Deaf

**Pedigree Illustrating the Inheritance of Congenital Deafness**

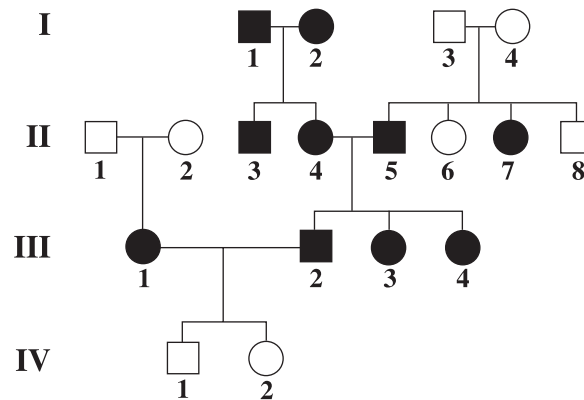

34. The evidence in the pedigree that two different genes interact in the inheritance of congenital deafness is that
- A. more female than male offspring are affected
  - B. individuals I-3 and I-4 produced affected offspring
  - C. individuals II-4 and II-5 produced affected offspring
  - D. individuals III-1 and III-2 produced unaffected offspring

Use the following information to answer the next question.

Researchers at Memorial University in Newfoundland recently discovered the mutated gene that causes a disorder known as ARVC5. The disorder, which is characterized by the replacement of healthy heart tissue with fatty, fibrous tissue, results from the inheritance of one copy of the mutated gene. The researchers found the mutation on chromosome 3.

—based on Merner et al., 2008

Merner, Nancy D., Kathy A. Hodgkinson, Annika F. M. Haywood et al. 2008. Arrhythmogenic right ventricular cardiomyopathy type 5 is a fully penetrant, lethal arrhythmic disorder caused by a missense mutation in the *TMEM43* gene. *The American Journal of Human Genetics* 82 (April 11): 809–21.

35. The discovery of the gene for ARVC5 on chromosome 3 indicates that the disorder
- A. is transmitted primarily from fathers to sons
  - B. is transmitted primarily from mothers to sons
  - C. occurs more frequently in females than in males
  - D. occurs with equal frequency in males and females

Use the following information to answer the next question.

Researchers have constructed a genetic map of the chromosomes of *Schistosoma mansoni*, a parasitic blood fluke that causes chronic illness in humans. Some of the genes on chromosome 5 and the distances between them are shown in the table below.

Genes	Distance
1 and 3	13.0
2 and 3	24.3
2 and 4	8.2
3 and 4	16.1

—based on Criscione et al., 2009

Criscione, Charles D., Claudia L. L. Valentim, Hirohisa Hirai, Philip T. LoVerde, and Timothy J. C. Anderson. 2009. Genomic linkage map of the human blood fluke *Schistosoma mansoni*. *Genome Biology* 10, no. 6 (June 30), <http://genomebiology.com/2009/10/6/R71>.

## Numerical Response

7. What is the distance between gene 1 and gene 4?

Answer: \_\_\_\_\_

(Record your answer as a value rounded to one decimal place in the numerical-response section on the answer sheet.)

*Use the following information to answer the next question.*

An enzyme called RNase L breaks down RNA molecules in cells, which results in the inhibition of protein synthesis. RNase L is found in the nucleus of cells.

36. Which of the following steps in protein synthesis is affected **first** by the presence of RNase L?
- A. Movement of mRNA from the nucleus to the cytoplasm
  - B. Production of mRNA from a DNA template
  - C. Attachment of tRNA to an amino acid
  - D. Attachment of tRNA to the ribosome
- 
37. One role of tRNA in protein synthesis is to attach to
- A. an amino acid in the nucleus
  - B. an amino acid in the cytoplasm
  - C. a DNA molecule in the cytoplasm
  - D. an mRNA molecule in the nucleus

Use the following information to answer the next question.

**Some Events in a Cell**

Structure I	Structure II	Process	Location
1 DNA	1 DNA	1 Replication	1 Nucleus
2 mRNA	2 mRNA	2 Transcription	2 Cytoplasm
3 Amino acid	3 Amino acid	3 Translation	

### Numerical Response

8. Using the numbers given above, identify Structure I, Structure II, the process illustrated in the diagram above, and the location in the cell where the process takes place.

Answer: \_\_\_\_\_  
**Structure I      Structure II      Process      Location**

(Record all **four digits** of your answer in the numerical-response section on the answer sheet.)

\_\_\_\_\_

Use the following information to answer the next two questions.

Some forms of deafness are caused by mutations in the connexin 26 gene. One mutation results from the deletion of 9 base pairs.

—based on *Human Gene Mutation Database*, 2010

Institute of Medical Genetics. 2010. Gene symbol: *GJB2*. *Human Gene Mutation Database*. Cardiff University. [www.hgmd.cf.ac.uk/ac/index.php](http://www.hgmd.cf.ac.uk/ac/index.php).

38. Compared with the protein coded by the normal connexin 26 gene, the protein coded by the mutated form of the gene described above is expected to have
- A. 3 fewer amino acids
  - B. 9 fewer amino acids
  - C. 18 fewer amino acids
  - D. 27 fewer amino acids

Use the following additional information to answer the next question.

Another mutation in the connexin 26 gene involves the deletion of two bases and their replacement by two new bases. The deletion is shown below.



The two deleted bases are replaced by two adenine bases.

—based on *Human Gene Mutation Database*, 2010

Institute of Medical Genetics. 2010. Gene symbol: *GJB2*. *Human Gene Mutation Database*. Cardiff University.  
www.hgmd.cf.ac.uk/ac/index.php.

39. The transcription of the mutated connexin 26 gene described above results in the replacement of a
- A. stop codon with a lysine codon
  - B. methionine codon with a lysine codon
  - C. stop codon with a phenylalanine codon
  - D. methionine codon with a phenylalanine codon
- 

Use the following information to answer the next question.

#### A Section of a Gene

CTT TGA CAC TCC

#### Some Amino Acids

- 1 Valine
- 2 Serine
- 3 Arginine
- 4 Histidine
- 5 Threonine
- 6 Glutamate
- 7 Glutamine
- 8 Tryptophan

### Numerical Response

9. The amino acid sequence coded by the nucleotide sequence of the section of the gene shown above is \_\_\_\_\_, \_\_\_\_\_, \_\_\_\_\_, and \_\_\_\_\_.

(Record all **four digits** of your answer in the numerical-response section on the answer sheet.)

Use the following information to answer the next two questions.

Some researchers are developing a technology to test for the presence of different flu viruses in a person's blood. One step in the process involves using RNA as a template to produce DNA. The DNA that is produced is then cut into fragments.

40. Which of the following rows identifies the technology used to cut DNA into fragments and describes a property of the DNA fragments?

Row	Technology	Property of DNA Fragments
A.	Ligase enzymes	A sequence of nucleotides that contains thymine
B.	Ligase enzymes	A sequence of codons that contains uracil
C.	Restriction enzymes	A sequence of nucleotides that contains thymine
D.	Restriction enzymes	A sequence of codons that contains uracil

Use the following additional information to answer the next question.

Other researchers are testing for the presence of different flu viruses by using a technology known as a microarray. A glass chip is covered with tiny fragments of DNA that match sections of the genetic material of many different flu viruses. A blood sample from a patient with the flu is applied to the chip. Viral fragments in the patient's blood will stick to matching fragments on the chip, thus identifying the specific flu virus that has infected the patient.

—based on Townsend et al., 2006

Townsend, Michael B., Erica D. Dawson, Martin Mehlmann et al. 2006. Experimental evaluation of the FluChip diagnostic microarray for influenza virus surveillance. *Journal of Clinical Microbiology* 44, no. 8 (August): 2863–71.

41. Viral fragments from a patient stick to viral fragments on the chip when a
- A. purine base in a viral fragment comes in contact with a purine base on the chip
  - B. base in a viral fragment comes in contact with an identical base on the chip
  - C. pyrimidine base in a viral fragment comes in contact with a pyrimidine base on the chip
  - D. base in a viral fragment comes in contact with a complementary base on the chip

Use the following information to answer the next two questions.

Lactose intolerance is an autosomal recessive condition characterized by the inability to digest lactose. People who are either homozygous for the dominant allele or heterozygous are able to digest lactose. The frequency of lactose intolerance differs among populations. For example, 14% of northern Europeans have lactose intolerance.

—based on NCMHD Center of Excellence for Nutritional Genomics, 2009

The NCMHD Center of Excellence for Nutritional Genomics. 2009. Lactose intolerance. *Concepts in Nutrigenomics*. The NCMHD Center of Excellence for Nutritional Genomics. [http://nutrigenomics.ucdavis.edu/?page=Information/Concepts\\_in\\_Nutrigenomics/Lactose\\_Intolerance](http://nutrigenomics.ucdavis.edu/?page=Information/Concepts_in_Nutrigenomics/Lactose_Intolerance).

### Numerical Response

10. What is the frequency of the allele for lactose intolerance in the northern European population?

Answer: \_\_\_\_\_

(Record your answer as a value between 0 and 1 rounded to two decimal places in the numerical-response section on the answer sheet.)

Use the following additional information to answer the next question.

The frequency of the dominant allele associated with the ability to digest lactose has increased dramatically over time in the northern European population.

42. The dramatic increase in frequency over time of the dominant allele associated with the ability to digest lactose provides evidence of
- A. evolution in the population, which resulted from the selective advantage provided by the dominant allele
  - B. evolution in the population, which resulted from the environmental resistance provided by the dominant allele
  - C. genetic equilibrium in the population, which resulted from the selective advantage provided by the dominant allele
  - D. genetic equilibrium in the population, which resulted from the environmental resistance provided by the dominant allele



Use the following information to answer the next question.

The Roma are a group of traditionally nomadic people who wandered in search of food, work, and places to camp. Genetic analysis indicates that the Roma people descended from populations in India and Pakistan. Three main groups of Roma presently live in Europe, each of which originated when a few individuals broke away from the parent population and formed new isolated communities.

43. The establishment of three isolated Roma populations in Europe illustrates
- A. natural selection
  - B. the founder effect
  - C. the bottleneck effect
  - D. ecological succession

Use the following information to answer the next two questions.

To study the effect of grazing on biodiversity in a grassland community, scientists prevented sheep and rabbits from accessing a particular area of the grassland. They discovered that biodiversity decreased in areas where grazing did not occur because grazing prevents the most successful plant species from overtaking an area. When grazers consume successful plant species, some of the less successful plant species are given a chance to grow.

—based on *Nature*, 2005

Moore, Peter D. 2005. Parasite rattles diversity's cage. *Nature* 433, no. 7022 (January 13): 119.

44. Plant species that consistently remain in the grassland community where grazing is prevented are known as
- A. seral species
  - B. climax species
  - C. pioneer species
  - D. intermediate species
45. Grazing increases biodiversity in a grassland by decreasing the
- A. gene flow of less successful plant species
  - B. genetic drift of more-successful plant species
  - C. interspecific competition for less successful plant species
  - D. interspecific competition for more-successful plant species

Use the following information to answer the next question.

Mountain pine beetles tunnel under the bark of pine trees and lay eggs, which hatch into larvae. The larvae feed on the trees, a process that severely damages but does not kill the trees. Mountain pine beetles often carry and distribute spores from bluestain fungus. The presence of the bluestain fungus helps the beetles invade a tree. The bluestain fungus eventually kills the pine trees.

46. Which of the following rows identifies the relationship between a mountain pine beetle and a bluestain fungus and the relationship between a mountain pine beetle and a pine tree?

Row	Mountain Pine Beetle and Bluestain Fungus	Mountain Pine Beetle and Pine Tree
A.	Commensalism	Predation
B.	Commensalism	Parasitism
C.	Mutualism	Predation
D.	Mutualism	Parasitism

Use the following information to answer the next question.

Northern pike are fish that were introduced into the south-central area of Alaska in the 1950s by a fisherman. Scientists believe that increasing numbers of northern pike are reducing populations of salmon in this region. Northern pike eat large numbers of young salmon before the salmon leave to mature in the ocean.

—based on *Nature*, 2002

Dalton, Rex. 2002. Pike pests ravage Alaska's salmon. *Nature* 418, no. 6901 (August 29): 907.

47. Scientists believe that the decrease in the salmon population in south-central Alaska is caused by northern pike
- A. emigration, which causes a decrease in salmon mortality
  - B. emigration, which causes an increase in salmon mortality
  - C. immigration, which causes a decrease in salmon mortality
  - D. immigration, which causes an increase in salmon mortality

Use the following information to answer the next question.

In 1957, French scientists transported two wild Corsican mouflon sheep to Haute Island, which has an area of  $6 \text{ km}^2$  and is located midway between Africa and Antarctica. By 1977, the flock had grown to 700 sheep.

—based on Kaeuffer et al., 2007

Kaeuffer, Renaud, David W. Coltman, Jean-Louis Chapuis, Dominique Pontier, and Denis Réale. 2007. Unexpected heterozygosity in an island mouflon population founded by a single pair of individuals. *Proceedings of the Royal Society B* 274 (February 22): 527–33.

### Numerical Response

11. What was the density of the wild Corsican mouflon sheep population on Haute Island in 1977?

Answer: \_\_\_\_\_ sheep/ $\text{km}^2$

(Record your answer as a whole number in the numerical-response section on the answer sheet.)

\_\_\_\_\_

Use the following information to answer the next question.

The woodland caribou, *Rangifer tarandus*, has been declared a species at risk. In 1982, there were an estimated 193 260 woodland caribou in Canada. By 2002, the population had declined to an estimated 188 850.

—based on Environment Canada, 2003

Environment Canada. 2003. Woodland Caribou. *Species at Risk*. Environment Canada, [www.speciesatrisk.gc.ca/search/speciesDetails\\_e.cfm](http://www.speciesatrisk.gc.ca/search/speciesDetails_e.cfm) (accessed August 15, 2003).

### Numerical Response

12. What was the per capita growth rate of the woodland caribou population between 1982 and 2002?

Answer: – \_\_\_\_\_

(Record your answer as a value between 0 and 1 rounded to two decimal places in the numerical-response section on the answer sheet.)

*Use the following information to answer the next question.*

Red lionfish are native to the waters of the southern Pacific Ocean, the Indian Ocean, and the Red Sea. Approximately five times per month, female red lionfish release more than 1 000 eggs at one time into the water, where fertilization takes place. Within a day, the fertilized eggs hatch into larvae, which then migrate to the ocean floor.

- 48.** The expected growth pattern and growth curve of the red lionfish population in the southern Pacific Ocean are, respectively,
- A.** exponential and S-shaped
  - B.** exponential and J-shaped
  - C.** logistic and S-shaped
  - D.** logistic and J-shaped